

# RAJA

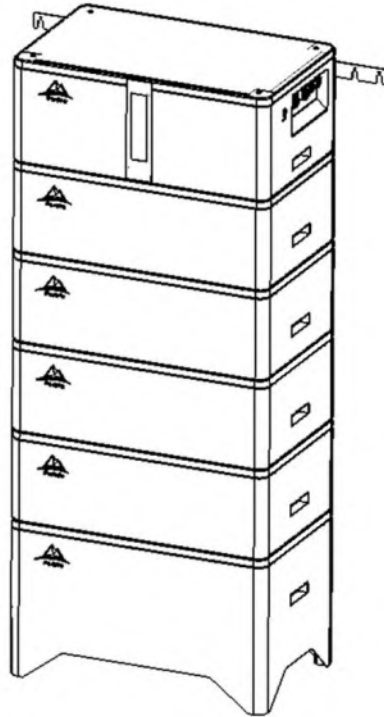

*Smart Residential Energy Storage Solutions  
Manage Energy Intelligently and Effectively*

## USER MANUAL

### Lithium Ion Battery System

### FD3000A Series

V1.0-2023-02-02

## CONTENT

1. Preface.....	
1.1 Applicable Product .....	1
1.2 Target Group.....	1
1.3 Symbols & Marks.....	1
1.4 Version History .....	1
2. Safety.....	2
2.1 General Safety .....	2
2.2 Battery Safety .....	2
2.3 Safety Measures in Emergency.....	4
3. Product.....	4
3.1 Description.....	4
3.2 Application Scenario.....	
3.3 Appearance.....	5
3.3.1 Appearance of FD3000A&FD5000C.....	5
3.3.2 Appearance of FD5000A .....	
4. Product Inspect and Store.....	7
4.1 Unpacking and Inspection.....	7
4.2 Parts & accessories included.....	
4.3 Product Storage .....	7
5. Installation.....	8
5.1 Installation Requirement.....	8
5.1.1 Environmental Requirement .....	8
5.1.2 Requirement on mounting parts.....	8
5.1.3 Installation Angles .....	8

5.2 Battery System Installation .....	8
5.2.1 Moving and lifting the product.....	8
5.2.1 Installing .....	9
6. Electrical Connection.....	10
6.1 Safety Precautions.....	10
6.2 Electrical Connection .....	10
6.3 Grounding/Earthing Wire .....	11
6.4 Positive and Negative Poles .....	11
6.5 Communication Wire .....	11
7. Operating.....	12
7.1 Inspection before Starting .....	12
7.2 Starting the system.....	12
7.3 Display Screen .....	12
8. Maintenance.....	13
8.1 System Shutdown .....	13
8.2 Regular Maintenance .....	13
9. Parameters.....	

# 1. Preface

This User Manual mainly introduces the product information, installation and wiring, configuration and commissioning, troubleshooting and maintenance of the battery system. Before installing and using this product, please read this manual carefully to understand product safety information and be familiar with the functions and features of the product.

## 1.1 Applicable Product

This User Manual is applicable to below product:



- FD3000A

## 1.2 Target Group

It is only suitable for professionals who are familiar with local regulations, standards and electrical systems, have received professional training, and are familiar with the relevant knowledge of this product.

## 1.3 Symbols and Marks

In order to understand manual better, the following symbols are used in the manual to highlight relevant important information, please read the symbols and instructions carefully.

 <b>DANGER!</b>
Indicates a potentially hazardous situation which, if not avoided, will result in death or serious injury.
 <b>WARNING!</b>
Indicates a hazardous situation with a medium level of potential which, if not avoided, could result in death or serious injury.
 <b>CAUTION!</b>
Indicates a hazard with a low level of potential which, if not avoided, may result in moderate or minor injury.
<b>NOTE</b>
Emphasis and supplements to the content may also provide tips or tricks for optimizing the use of the product, which can help you solve a certain problem or save you time.

## 1.4 Version History

V1.0 2023-02-02 First Release

## 2. Safety

All safety precautions contained in this document must be followed when operating the equipment.

### NOTE

The equipment has been completely tested according to the national standard before leaving the factory, and the test is qualified. However, when delivering the product, the box is separated and packaged for delivery. Therefore, when assembling on site, it must be installed in strict accordance with the requirements of this manual, otherwise it will cause serious damage and property loss.

### 2.1 General Safety

#### NOTE

- This manual will be updated irregularly due to product version upgrades or other reasons, but the safety precautions in the manual will not be replaced under normal circumstances, and other contents in the manual are only used as a guide for product use.
- Before installing the product, please read this manual carefully to understand the product and related precautions.
- All operations of the product must be carried out by professional and qualified electrical technicians, and the technicians must be familiar with the relevant standards and safety regulations of the place where the product is installed.
- When operating the product, it is necessary to wear insulated tools and personal protective equipment to ensure personal safety. When touching electronic devices, you need to wear electrostatic wristbands and other appliances to prevent products from being damaged by static electricity.
- If the requirements of the manual are not followed during installation and use, all losses and personal injuries caused are not within the scope of responsibility of the company.















### 2.2 Battery Safety

#### DANGER!

- This series of products is a high-voltage system, and there is high pressure when the product is running. When operating the product, please ensure that the product is powered off to prevent the risk of electric shock. All safety precautions in this manual must be strictly observed during the operation of the equipment.
- The inverter used with the battery needs to be approved by the company, and the approved inverter can be obtained through product sales personnel.
- Without the authorization of the company, please do not disassemble, modify, or repair the battery or high-voltage box, otherwise it may cause equipment damage or personal injury, and the resulting loss is not within the scope of the company's responsibility.
- Do not bump, pull, drag, squeeze or step on the product, and do not put the battery in fire or immerse in water, otherwise the battery may catch fire or explode.
- Do not place the battery in a high-temperature environment. Make sure that there is no heat source near the battery and no direct sunlight. When the ambient temperature exceeds 60°C, a fire may occur.
- If you find that the battery box or high-voltage box has obvious defects, cracks, damage, etc. after receiving the product, please do not use it and contact us in time for corresponding solutions.
- The battery product is heavy, please equip enough personnel according to the weight to avoid accidents during the handling process.
- If the product cannot be started after assembly, please contact our company as soon as possible.

 WARNING!	
<ul style="list-style-type: none"> <li>● Ensure that the battery is not damaged during transportation and storage.</li> <li>● Make sure that the device is placed firmly and cannot be tilted, otherwise the product will fall over and cause personal injury and equipment damage.</li> <li>● Cables of the same type should be bundled together, and cables of different types should be bundled at least 30 mm apart. Intertwining or cross-bundling is prohibited.</li> </ul>	

### Symbols & Marks

	There is a potential hazard when the equipment is in operation. Use protection when operating equipment.		Keep equipment away from open flames or sources of ignition.
	Danger of high voltage. When operating the device, be sure that the device is powered off.		Keep the device out of the reach of children.
	Please use the device properly. The device may explode if use in extreme circumstances.		Do not use water to extinguish fire.
	The device contains corrosive electrolyte. Please avoid contact with leaked electrolyte or volatile gas.		The device cannot be treated as household waste. Please dispose of the device according to local laws and regulations, or send it back to the device manufacturer.
	Batteries contain flammable materials, beware of fire.		Recycle sign.
	Before operating the equipment, please read the product manual carefully.		CE certification mark.
	Wear personal protective equipment during installation, operation and maintenance.		Protective earth connection point.

### 2.3 Safety Measures in Emergency

#### In case of "Fire"

- When the temperature exceeds 150°C, the battery is at risk of fire, and the battery may release toxic and harmful gases after fire.
- To avoid fire, please make sure there is a carbon dioxide, Novac1230 or FM-200 fire extinguisher near the equipment.
- When extinguishing the fire, do not use water or ABC dry powder to extinguish the fire. Firefighters must wear protective clothing and self-contained breathing apparatus.

#### In case of "Battery Electrolyte Leakage"

Avoid contact with the leaked liquid or gas. Electrolyte is corrosive and contact may cause skin irritation and burns. If you accidentally come into contact with spilled material, do the following:

- Inhalation: Evacuate from contaminated area and seek medical help immediately.
- Eye contact: Rinse with water for at least 15 minutes and seek medical help immediately.
- Skin contact: Wash the affected area thoroughly with soap and water, and seek medical help immediately.
- Ingestion: Induce vomiting and seek medical attention immediately.

## 3. Product

### 3.1 Description

#### Function Overview

FD3000A system is composed of 1 battery base module, battery modules and 1 high-voltage control module. It can store and release electricity according to the requirements of the photovoltaic energy storage system. The input and output ports of the energy storage system are high-voltage DC(Direct Current).

#### Available Power

The battery system supports a maximum of 6 battery modules of expansions to increase the power according to user's actual needs.

For example, a 15kWh system comes with "high-voltage control module + 4 battery modules + 1 battery base module", below picture shows how a 15kWh system looks like,

15kWh FD3000A

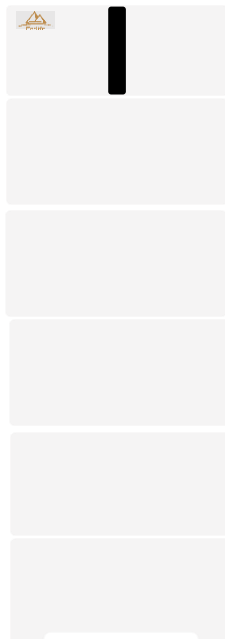

### 3.2 Application Scenario

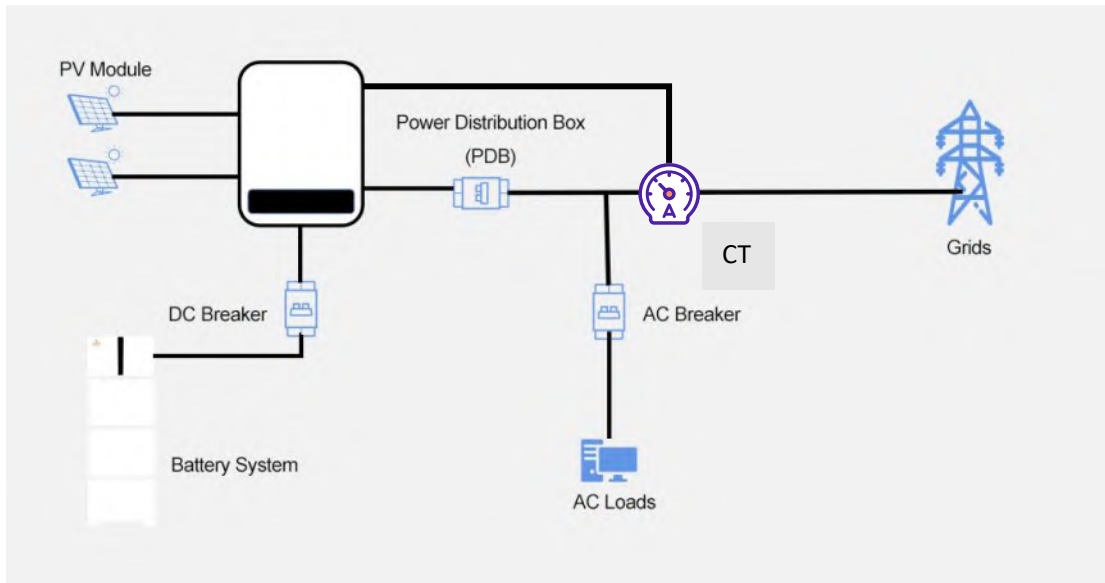

#### Applicable Inverters

Please contact the seller or manufacturer for the inverters that match the batteries.

### 3.3 Appearance

#### FD3000A Battery System

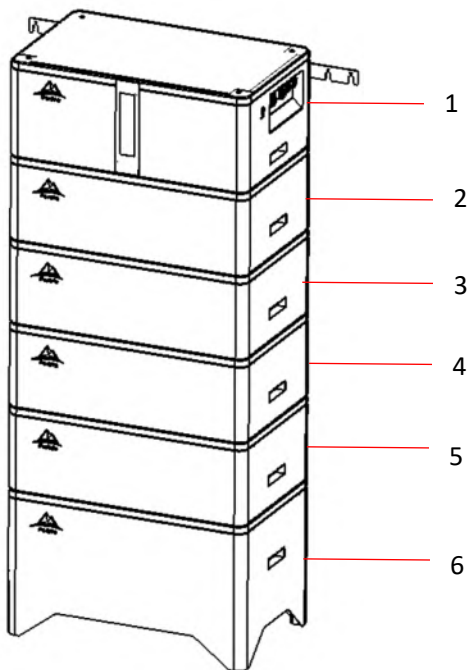

NOTE	
<ul style="list-style-type: none"> <li>Make sure that the high-voltage control module is mounted on the top of the stack, reverse mounting or mounting in the wrong order will cause damage to the system, and the system will not work</li> </ul>	

S/N	Name
1	High-voltage control module
2,3,4,5	Battery Module
6	Battery Base Module



Battery Module

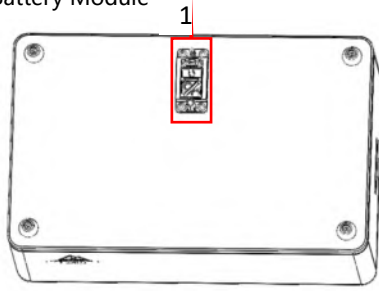

S/N	Name
1	Quick connector

Battery Base Module

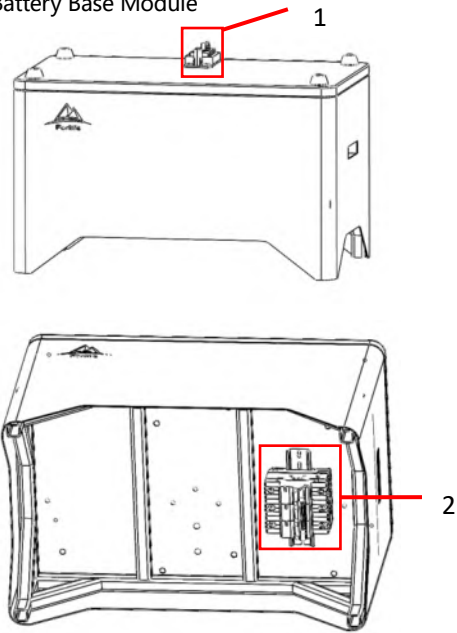

S/N	Name
1	Quick Connector
2	DC Breaker

High-voltage Control Box

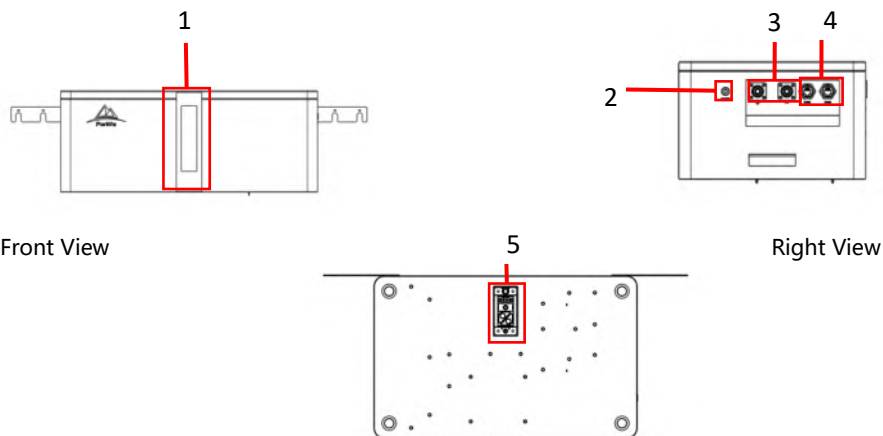

Front View

Right View

Bottom View

S/N	Name	S/N	Name	S/N	部件
1	Display Screen	3	AC Output	5	Quick Connector
2	Switch Button	4	Communication		

## 4. Product Inspect and Store

### 4.1 Unpacking and Inspection

Before unpacking, please check the following in detail:

1. Check whether the outer package is damaged, such as deformation, opening, crack or other details that may cause damage to the equipment in the box. If there is any damage, please do not open the package and contact your dealer.
2. Check if the device is exactly the one you buy, if not, please do not open the package and contact your dealer.
3. Check whether the type and quantity are correct, and whether the appearance is damaged. In case of damage, please contact your dealer.

### 4.2 Parts & accessories included

Name	NOS	Remark
High-voltage Control Module	1	
Battery Module	1~5	Optional as per actual demand
Battery Base Module	1	
Anti-tilt Bracket	2	
Expansion Bolt	4	
User Manual	1	
Cables	3	Power Cable 2pcs Communication cable 1pc

### 4.3 Product Storage

If the device will not be used immediately, store it as follows:

1. Make sure that the outer packing box is not removed and the desiccant in the box is not lost.
2. It is recommended to complete the equipment installation within 3 days after removing the packing box. If the equipment is not installed, the original packing box should be used to repack the equipment for storage.
3. Make sure that the stacking height and direction of the equipment are placed according to the instructions on the label on the packaging box.
4. Ensure that there is no risk of dumping after the equipment is stacked.
5. Make sure the equipment is stored away from flammable, explosive, corrosive and other items.
6. Make sure the device is stored in a cool place out of direct sunlight.
7. Make sure the storage environment is clean, with a suitable temperature and humidity range and no condensation.
8. Storage battery SOC range: 25%~50%SOC, a charge-discharge cycle is required every 3 months of storage.
9. Storage temperature range: the best storage temperature is 10~35°C.
10. Storage humidity range: 0~95%RH without condensation. It cannot be installed when there is moisture condensation on the battery interface.

## 5. Installation

### 5.1 Installation Requirement

#### 5.1.1 Environmental Requirement

1. The equipment cannot be installed in flammable, explosive and corrosive environments.
2. The installation location should be kept out of the reach of children, and should not be installed in places that are easy to touch. The surface may be hot when the equipment is in operation to prevent burns.
3. The installation location should avoid water pipes, cables, etc. in the wall to avoid danger when drilling holes.
4. The installation environment needs to avoid the sun, rain, snow, etc. It is recommended to install in a sheltered installation location, and a sunshade can be built if necessary.
5. The installation space must meet the equipment ventilation and heat dissipation requirements and operating space requirements.
6. The protection level of the equipment meets indoor and outdoor installation, and the temperature and humidity of the installation environment must be within the appropriate range.
7. The installation height of the equipment should be convenient for operation and maintenance, ensure that the display screen and all labels of the equipment are easy to view, and the terminal blocks are easy to operate.
8. The installation altitude of the equipment is lower than the maximum working altitude of 2000m.
9. Keep away from strong magnetic field environment to avoid electromagnetic interference. If there are radio stations or wireless communication equipment below 30MHz near the installation location, please ensure that the distance between the battery and the wireless electromagnetic interference equipment is greater than 30m.

#### 5.1.2 Requirement on mounting parts

1. The mounting parts cannot be made of flammable materials, and must have fireproof performance.
2. Please ensure that the mounting parts are sturdy and reliable, and can bear the weight of the device.
3. The battery system needs to be installed close to the wall, and an anti-tilt bracket should be installed to avoid unnecessary personal and property losses caused by the battery tipping over.

#### 5.1.3 Installation Angle

1. Make sure the equipment is installed horizontally and cannot be dumped or turned upside down.
2. Before installation, find a level ground for product installation.

### 5.2 Battery System Installation

#### 5.2.1 Moving and lifting the product



All the practices like transportation, turnover, and installation, must follow the relevant local standards and regulations of the country.

- To avoid personal injury or equipment damage during the transport process, please pay attention to the following:
  1. Please equip corresponding personnel according to the weight of the equipment, so as to prevent the equipment from exceeding the weight range that the human body can carry and hurting people.
  2. Please wear safety gloves to avoid injury.
  3. Please ensure that the device is kept balanced during transportation to avoid falling.

## 5.2.2 Installation

### NOTE

- Make sure the Battery Base Module is perpendicular to the ground.
- The battery base module, battery module, and high-voltage control module are against the wall, and the quick connector on the battery base module are facing inward (against the wall) when placed.
- The upper and lower holes are aligned when placing the upper battery module.
- The back of the battery module is close to the wall, and both sides of the high-voltage control module need to be mounted with anti-tilt brackets.

Battery Module installation steps:

Step 1: Find the appropriate site to have the battery base module installed.

Step 2: The battery module should be installed above the battery base module, make sure that the direction of the battery module is consistent with that of the battery base module.

Step 3: Install the remaining battery modules according to the type of battery system and the number of battery modules actually selected.

High-voltage control module installation:

### NOTE

- When punching holes, cover the device with cardboard or other blocking objects to prevent foreign matter from entering the device.
- The anti-tilt bracket of the high-voltage control module must be close to the wall, and the bottom of the high-voltage control module must be close to the battery module.

Step 1: Install the anti-tilt bracket on the module.

Step 2: The high-voltage control module should be installed above the battery module, make sure it is placed firmly, mark the hole position with a marker pen, and remove the high-voltage control module.

Step 3: Drill holes with a percussion drill;

Step 4: Fasten the anti-tilt bracket of the high-voltage control module.

## 6. Electrical Connection

### 6.1 Safety Precautions

#### DANGER!

- There are high voltage system products in this manual, and high voltage exists when the equipment is in operation. Before operating the equipment in the system, please ensure that the equipment is powered off to avoid the risk of electric shock. During the operation of the equipment, all safety precautions in this manual and the safety marks on the equipment must be strictly followed.
- All operations, cables and component specifications used during the electrical connection must comply with local laws and regulations.
- Cables of the same type should be bundled together and arranged separately from cables of different types. Intertwining or crossing arrangement is prohibited.

#### NOTE

- Please wear personal protective equipment such as safety shoes, protective gloves, and insulating gloves as required.
- Only qualified personnel are allowed to carry out the work related to electrical connection.
- The cable colors in the graphics in this document are for reference only, and the specific cable specifications must comply with local regulations.

### 6.2 Electrical Connection

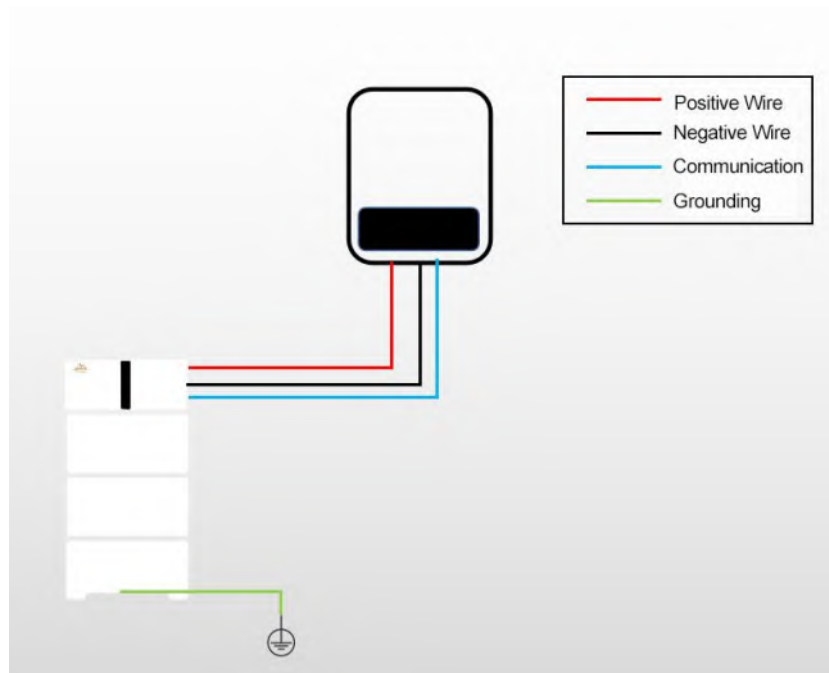

### 6.3 Grounding/Earthing Wire

NOTE	
<ul style="list-style-type: none"> <li>● When installing, the protective ground wire must be installed first, when removing equipment, the protective ground wire must be removed last.</li> <li>● Please bring your own protective ground wire, recommended specification: outdoor single-core copper wire (4-6mm<sup>2</sup>).</li> <li>● The protective ground wire is at the grounding point inside the Battery Base Module.</li> </ul>	

### 6.4 Positive and Negative Poles

NOTE	
<ul style="list-style-type: none"> <li>● Before connecting the positive and negative wires, please turn off the power to avoid danger.</li> <li>● Positive and negative wires are provided by manufacturer.</li> <li>● After plugging in the positive and negative plug-ins, please confirm whether the connection is complete.</li> <li>● Please note that the ends of the positive and negative wires are crimped terminals, please connect the terminals to the inverter and then perform quick plug connection.</li> </ul>	

### 6.5 Communication Wire

NOTE	
<ul style="list-style-type: none"> <li>● The communication interfaces on two batteries have the same function.</li> <li>● Two communication interfaces can be connected to one.</li> <li>● If the communication cable on the battery side needs to be remade, please refer to the following communication interface definition.</li> </ul>	

#### RJ45 Terminal

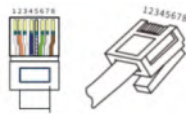

#### Definition

PIN	COM1	Description
1	N/A	
2	N/A	
3	N/A	
4	CAN_H	Connect to the BMS COMM on the inverter , so the battery can communicate with the inverter.
5	CAN_L	
6	N/A	
7	GND	PIN for grounding
8	N/A	

## 7. Operating

### 7.1 Inspection before Starting

When the battery system is powered on, please be sure to check the following to prevent system damage.

S/N	Details to be ensured
1	The equipment is firmly installed, the installation site is convenient for operation and maintenance, the installation space is convenient for ventilation and heat dissipation, and the installation environment is clean and tidy.
2	The protective ground wire, power wire, and communication wire are connected correctly and firmly.
3	The cable binding meets the routing requirements, the distribution is reasonable, and there is no damage.
4	Unused ports are blocked.

### 7.2 Starting the system

NOTE
The circuit breaker between the inverter and the battery must be installed according to local laws and regulations.

Step 1: Press the low voltage button switch to activate the main control system.

Step 2: Turn off the breaker on the battery base module.

Step 3: Power on the inverter. For detailed operations, refer to the user manual of the inverter of the corresponding model.

### 7.3 Display Screen

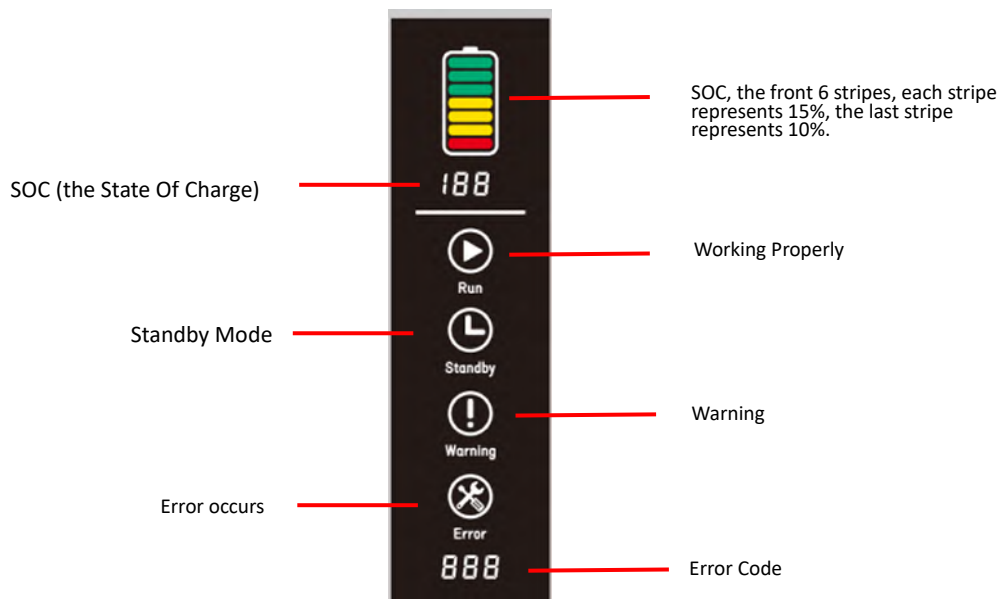

## 8. Maintenance

### 8.1 System Shutdown

 <b>DANGER!</b>
<ul style="list-style-type: none"> <li>• Before operating and maintaining the battery system, please make sure the system is powered off.</li> </ul> <p>Operating the system when it is powered on may cause permanent damage or electric shock hazard.</p> <ul style="list-style-type: none"> <li>• The beaker should be used when restarting the battery system.</li> </ul>

When shutting down the battery system, follow below steps to prevent damage:

#### Method 1

Step 1: Power off the inverter. For detailed operations, refer to the inverter user manual of the corresponding model.

Step 2: Press the low-voltage button switch to confirm that the display screen of the high-voltage control module is off.

#### Method 2

Step 1: Power off the inverter. For detailed operations, refer to the inverter user manual of the corresponding model.

Step 2: Disconnect the breaker on the battery base module, and confirm that the display screen of the high voltage control module is off.

### 8.2 Regular Maintenance

 <b>WARNING!</b>
<ul style="list-style-type: none"> <li>• If any factor that may affect the battery or energy storage inverter system, please contact the after-sales personnel, and it is forbidden to disassemble it without permission.</li> <li>• If the copper wire inside the conductive wire is exposed, do not touch it. High voltage is dangerous, please contact the after-sales personnel, and it is forbidden to disassemble it without permission.</li> <li>• In case of other emergencies, please contact the after-sales personnel immediately, operate under the guidance of the after-sales personnel, or wait for the after-sales personnel to operate on site.</li> </ul>

Maintenance points	How Often
Anti-tilt bracket: Fasten the corresponding position if it loosens.	Every 6 months
The housing of the modules: If it is damaged, please recoating or contact the after-sales service center.	Every 6 months
The exposed wires: If any are worn, please replace the corresponding wires or contact the after-sales service center.	Every 6 months
Debris accumulated around the battery system: Please clean it up so as not to affect the heat dissipation of the battery.	Every 6 months
Keep away from water or pests to avoid long-term intrusion into the battery.	Every 6 months



## 9. Parameters



High Voltage Stackable Battery Modular					FD3000A
NOS of Modules	2	3	4	5	6
Battery Energy	6kWh	9kWh	12kWh	15kWh	18kWh
Battery Capacity	30Ah				
Rated Voltage	204V	307V	409V	512V	614V
Working Voltage	160~233	240~350	320~467	400~584	480~700
NOS of Cells	2P64S	2P96S	2P128S	2P160S	2P192S
Battery type	LFP				
Cycle Life	> 6000				
Rated Charge Current	15A				
Rated Discharge Current	30A				
Display	LCD				
Communication	CAN				
Working Temperature	Charge: 0~45℃ Discharge: -20~60℃				
Storage Temperature	10~35℃				
Relative Humidity	0~95%				
Highest Altitude	2000				
Dimension	520*320*510mm	520*320*690mm	520*320*870mm	520*320*1050mm	520*320*1230mm
Weight	70kg	100kg	130kg	160kg	190kg
Protection Level	IP65				
Mounting	Stacking on the ground				
Standards & Certification	UN38.3/MSDS/FCC				



成都雅骏新能源科技有限公司  
RAJA NEW ENERGY TECHNOLOGY CO., LTD

☎ 086-189-2848-8391 086-189-3885-5861  
📍 成都市天府新区新兴工业园B1-4栋  
Building B1-4, Xinxing Industrial Park, Tianfu New Area, Chengdu, China  
✉ info@rajaev.com  
🌐 www.rajaev.com

